

stopper

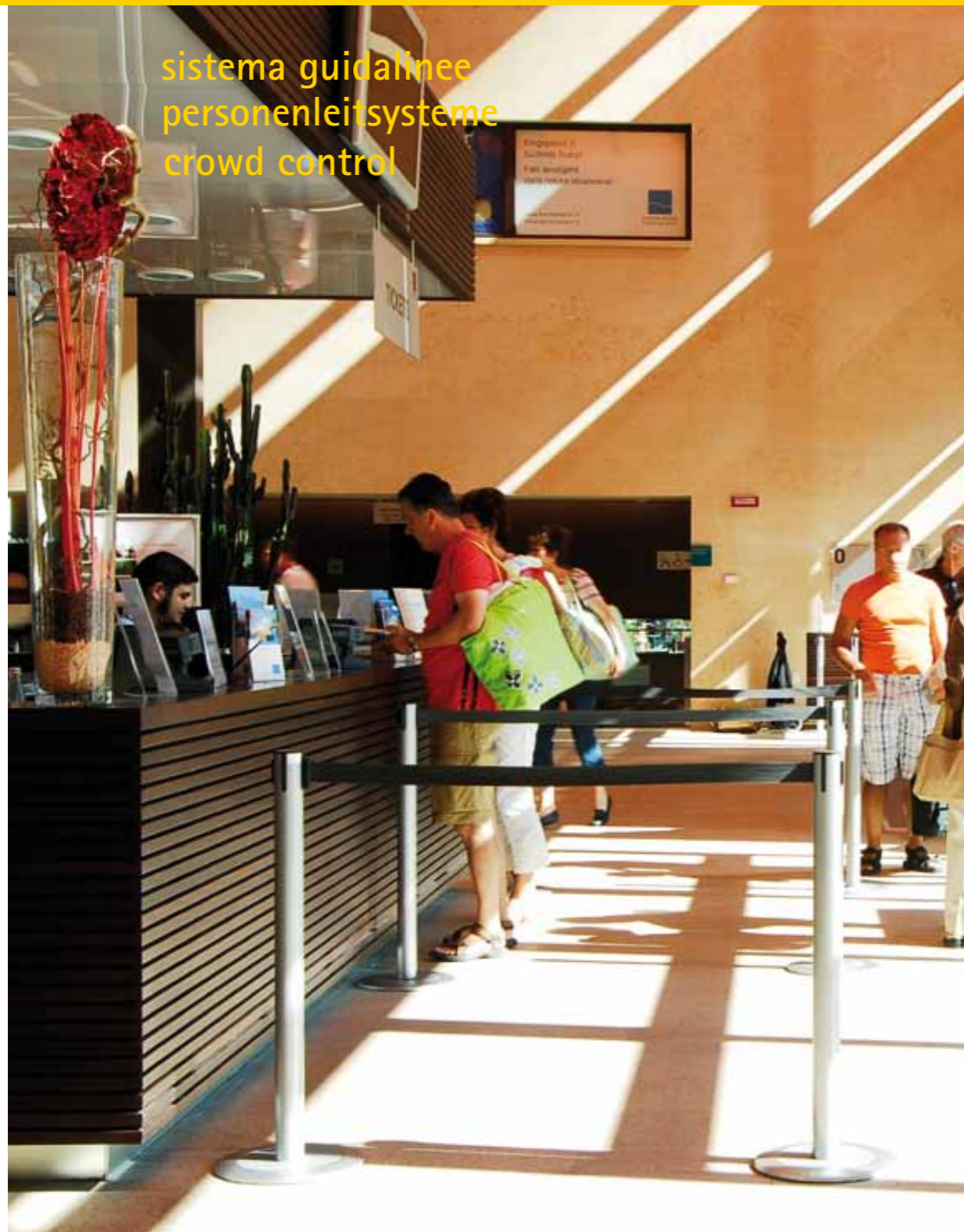

sistema guidalinee
personenleitsysteme
crowd control

sistema guidalinee

IT nastro oppure cordone, moderno oppure classico? scegliete ciò che più preferite dal nostro ricchissimo programma di guidalinee stopper. assicuratevi inoltre ulteriori vantaggi espositivi grazie alla linea di accessori. stopper è la scelta giusta per tutti quelli che sanno dove andare.

personenleitsysteme

DE gurt oder seil, modern oder klassisch? wählen sie aus dem grossen anbot von stopper personenleitsystemen ihre ausführung. mit den stopper accessoires weitere vorteile sichern. stopper ist die richtige entscheidung für alle die wissen wo's lang geht.

crowd control

EN belt or rope, modern or classic? the large assortment of stopper will provide you with the crowd control you are looking for. gain further advantage and ensure efficiency with stopper accessories. stopper: have it your way!

stopper 218-219	stopper over-view 220-221	master & eco base 222	stopper wall 223	my stopper 224-225	stopper accessories 226-227	wave 228	rondo 229
tex 230-231	tex double 232-233	tex alu 234	tex alu mini 235	tex wall 236-237	tex cord 238-239	tex accessories 240-241	



stand in line with italian design

IT stopper è il sistema guidalinee eliminacode sviluppato e prodotto da kunstdünger che sta ricevendo ampi consensi dalla clientela mondiale. ovunque ci siano da dirigere dei flussi di persone, stopper entra in azione: aeroporti, stazioni, centri commerciali, teatri, cinema, musei, stadi e durante manifestazioni culturali e sportive, ma anche in posta, in banca, presso le assicurazioni e in tutti gli uffici pubblici. in questi casi stopper assume due funzioni: direzione e sicurezza. strutturate e dirigete il flusso di persone in attesa garantendone allo stesso tempo il diritto alla privacy, come per esempio succede agli sportelli. inoltre potete impedire l'accesso a luoghi interdetti al pubblico. la già vasta gamma viene ampliata continuamente. con il presente catalogo siamo in grado di fornirvi oltre 4500 possibilità di combinazioni standard, a vostra scelta, grazie ai materiali insoliti, ai nuovi colori e alla personalizzazione del nastro e della base con la stampa digitale. siamo inoltre volentieri a disposizione per ulteriori consigli e suggerimenti.

DE stopper das personenleitsystem von kunstdünger entwickelt und produziert, überzeugt kunden weltweit. wo immer menschen zusammenkommen ist stopper im einsatz: flughäfen, bahnhöfe, kaufhäuser, theater, kinos, museen, stadien, messen, kultur- oder sportveranstaltungen, sowie natürlich bei post, bank, versicherungen und behörden aller art. dabei übernimmt stopper zwei aufgaben: leiten und sichern. strukturieren und führen sie die wartenden und sichern sie zugleich privatsphäre z.b. am schalter. verhindern sie ausserdem unbefugtes betreten von nicht-öffentlichen bereichen. das sortiment wird von uns ständig weiterentwickelt. dieser katalog hat über 4500 mögliche standard-kombinationen für sie zur auswahl. ungewöhnliche materialien, neue farben oder die personalisierung von gurt und basis mit digitaldruck sind kein problem. fragen sie uns, wir beraten sie gerne.

EN customers worldwide choose stopper the crowd control system developed and produced by kunstdünger. wherever people come together, stopper is used: airports, railway stations, department stores, theaters, cinemas, museums, stadiums, fairs, cultural or sporting events as well as post offices, banks, insurers and offices of public authorities. on the job stopper serves two purposes: guiding and safeguarding. with stopper you guide and control the queue and guarantee privacy at the counter as well. furthermore stopper helps you to prevent trespassing into private areas. we continuously enhance the assortment. this catalogue offers you more than 4500 possible standard combinations to choose from. exceptional materials, new colours or customizing of webbings and bases with digital printing is no problem. we are looking forward to your particular request.



stopper – solo vantaggi!

IT guidare le persone con stopper significa risparmio di spazio, guadagno di tempo e riduzione di stress. clientela e personale sono chiaramente più rilassati, gli spazi vengono usati in modo ottimale e le procedure si snelliscono.

stopper – nur vorteile!

DE menschen leiten mit stopper heisst platz sparen, zeit gewinnen und stress vermindern. wartende wie personal sind deutlich relaxter, räume werden optimal genutzt und abläufe flüssiger.

stopper – only advantages!

EN guide persons with stopper means save space, win time and reduce stress. queuers and staff are definitely relaxter, premises are used better and the work flows gets smoother.

before

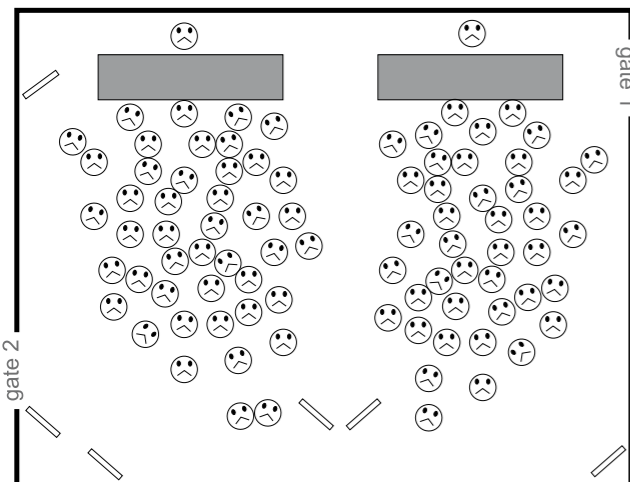

after

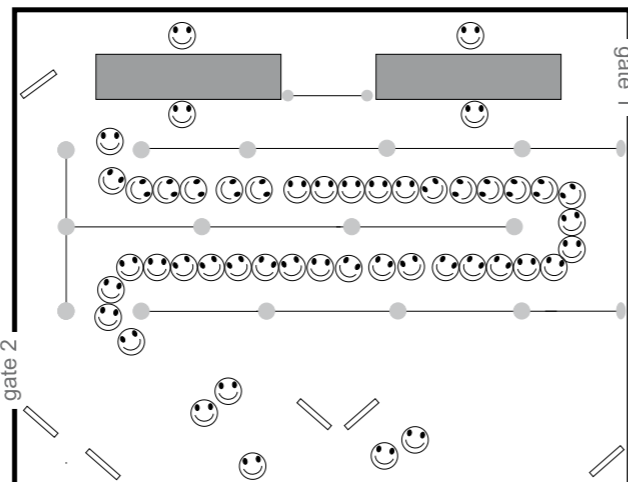

IT il meccanismo avvolginastro: in abs infrangibile, si monta senza l'utilizzo di viti o colle, mentre senza bisogno di ulteriori utensili il raccordo a 4 direzioni rende possibile l'aggiunta di altri stopper. tutte le parti visibili del raccordo e degli agganci sono senza spigoli, con forme rotondeggianti: per evitare ogni possibile ferita o danno agli abiti. il meccanismo avvolginastro in abs viene inserito nel tubo grazie alle scanalature laterali e al sistema autobloccante. per cambiare il meccanismo basta sganciare le molle grazie ai bottoncini laterali ed estrarlo.

DE die gurtkassette: aus bruchsthemer abs ohne schrauben und klebstoff montiert. an das 4-wege-gehäuse können sie weitere stopper anschliessen ohne zusätzliche adapter. alle hervorstehenden teile und sichtbaren kanten sind gerundet: keine verletzungsgefahr, kleidung kommt nicht zu schaden. das abs-gurtgehäuse wird in den pfosten eingeschoben und rastet sicher ein. zum austausch die verschlussfeder einfach per knopfdruck öffnen und gehäuse herausziehen.

EN the housing: made of breakproof abs plastics mounted ungummed and without screws. connect more stoppers to the 4-way housing without further adaptor necessary. all jutting parts and edges are rounded: no risk of injury, no damage to clothing. the housing made of abs plastics is simply inserted into the post and locks in safely. for changing just press the button to open and pull out the housing.



IT filetto per accessori: foro filettato M8 per tutti gli accessori.
DE das gewinde: integriertes M8 gewinde für alle accessoires.
EN thread for accessories: integrated M8 thread for all accessories.



IT il sistema frenante: integrato nel meccanismo, il freno regola la sua azione frenante in base alla velocità di rotazione dell'avvolginastro. il nastro viene riavvolto con la stessa velocità dall'inizio alla fine. si evitano così ferite alle mani e alle dita a causa di un riavvolgimento incontrollato e troppo veloce.

DE die brems: die eingebaute fliehkraftbremse passt ihre bremsstärke an die rotationsgeschwindigkeit des mechanismus an. das gurtband wird von anfang bis ende mit gleicher geschwindigkeit eingezogen. keine hand- und fingerverletzungen durch unkontrollierte ausschläge des bandes beim einzug.

EN the brake: the integrated brake adjusts its force according to the rotation speed of the mechanism. the tape is pulled back with the same speed over the full length. no sudden punches of the tape and no risk to injure hand or fingers.



IT la molla: appositamente per lo stopper abbiamo realizzato una speciale molla piatta in acciaio, con gli angoli arrotondati. il suo effetto si svolge linearmente su tutta la lunghezza del nastro. ciò significa che le colonnine rimangono stabili anche quando il nastro viene utilizzato per tutta la sua lunghezza e che il nastro stesso rimane perfettamente in tensione anche se usato solo per parte della sua lunghezza. con stopper avete la possibilità di utilizzare l'intera lunghezza di 3m in modo ottimale.

DE die feder: eigens für stopper haben wir eine stahl-flachfeder mit abgerundeten kanten entwickelt. ihre federwirkung verläuft linear. der zug auf den gurt wirkt immer gleichmässig. das heisst für sie: kein umfallen der pfosten durch zu starken zug bei vollauszug und ausreichende spannung auch bei geringem gurtauszug. mit stopper nutzen sie die gesamte gurtlänge von 3m optimal.

EN the spring: especially for stopper we designed a steel flat spring with linear resilience. the tape is under a constant tension. that means no toppling of the posts when the tape is completely moved out and enough tension even with little pullout to keep the tape straight. with stopper you use the full tape length of 3m.



IT il gancio di sicurezza: ogni nastro stopper è dotato di uno speciale gancio con una chiusura di sicurezza. il gancio si incastra sul raccordo del meccanismo ed impedisce che il nastro si stacchi inavvertitamente. per aprirlo basta premere leggermente il bottoncino. tale chiusura è standard in tutti i nastri disponibili. nelle prossime pagine troverete ulteriori vantaggi che vi offre il sistema stopper.

DE der verschluss: jedes gurtband hat einen verschluss mit sicherung. diese sicherung rastet ein und verhindert unbeabsichtigtes auslösen oder herausgleiten. zum öffnen genügt ein knopfdruck. diese sicherung ist standard bei allen gurtausführungen. noch mehr vorteile des stoppersystems finden sie auf den nächsten seiten.

EN the locking: every tape has a tamper-proof locking. this locking snaps in and prevents from unintended opening or sliding out. to open just press the button. this locking comes with all tape ends as a standard. find more stopper advantages on the following pages.

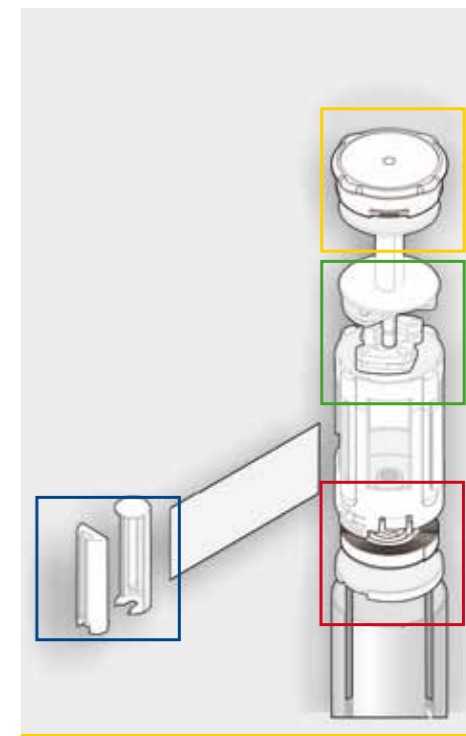

overview

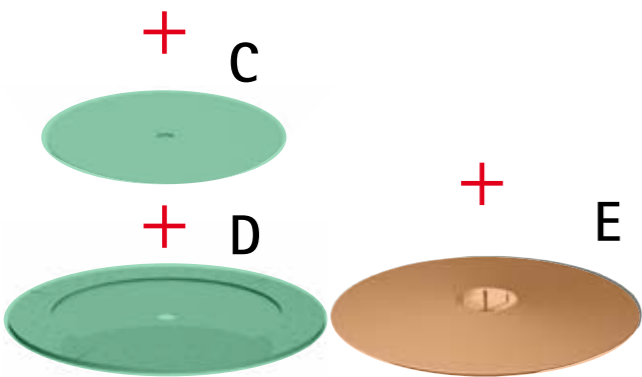
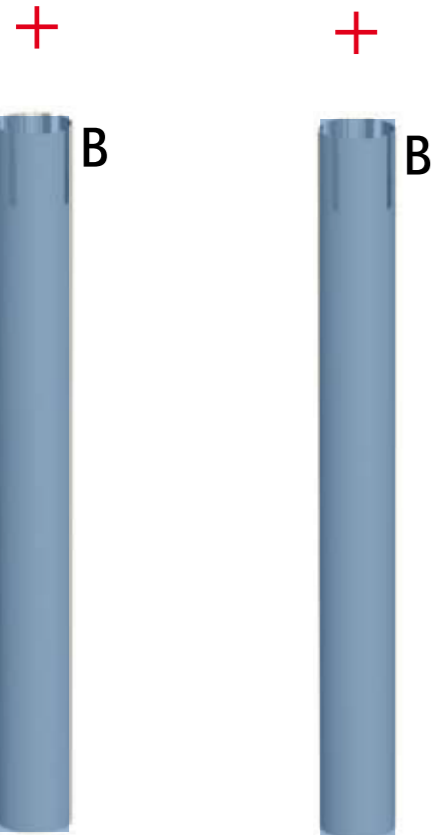

master

eco

meccanismo blu + nastro / gehäuse blau + gurt / housing blue + webbing

STGH12065BSW 33,00€	STGH12065BBL 33,00€	STGH12065BGR 33,00€	STGH12065BRT 33,00€

il prezzo comprende: meccanismo avvolginastro + nastro / die preise beinhalten gehäuse + gurt / the price comprehensive housing + webbing

meccanismo nero + nastro / gehäuse schwarz + gurt / housing black + webbing

STGH12065SSW 33,00€	STGH12065SRT 33,00€	STGH12065SBL 33,00€	STGH12065SGR 33,00€	STGH12065SYB 48,00€	STGH12065SWR 48,00€

il prezzo comprende: meccanismo avvolginastro + nastro / die preise beinhalten gehäuse + gurt / the price comprehensive housing + webbing

meccanismo avvolginastro vuoto / leeres gurtgehäuse / empty housing

STGHBL 7,00€	STGHSW 7,00€

tubo / pfosten / post

ST980AR 39,00€	ST980AL 33,00€	ST980CM 49,00€	ST980OT 49,00€	ST980IX 55,00€	ST980SW 39,00€	ST980PC 79,00€	ST980YE 39,00€	ST980RS 39,00€

*) tubo nichelato, spazzolato, verniciato trasparente con effetto acciaio inox. oberflächenveredelung: nickel matt, gebürstet mit transparent-lack für edelstahl-effekt. post: nickel-plated matt brushed surface, transparent varnished finish for stainless steel look.

master base / basis/ base

inserto centrale / dekorscheibe / decorative inlay

STKINSAR 19,00€	STKINSAL 19,00€	STKINSCM 33,00€	STKINSOT 26,00€	STKINSIX 16,00€	STKINSSW 19,00€	STKINSVE 16,00€

protezione in abs / trittschutzring / abs protection

STKABSAR 45,00€	STKABSGM 38,00€	STKABSSG 28,00€	STKABSSW 38,00€	STKABSRS 38,00€	STKABSBL 45,00€

eco base / basis/ base

STE330LG 31,00€	STE330CM 42,00€	STE330SZ 31,00€	ST330VE 33,00€

basi identificate con *) a causa della diminuzione del peso, lunghezza del nastro max. 2,5m / mit *) gekennzeichnete basen: aufgrund des geringeren gewichts gurtzug max. 2,5m / bases identified with *): due to the reduced weight webbing pullout is max. 2,5m



* fino ad esaurimento scorta | solange vorrat reicht | while stock last

a scelta libera

più di 4.500 possibilità per creare il vostro stopper preferito! componete il vostro stopper: A meccanismo avvolginastro + B tubo per la base master + C inserto centrale + D protezione in abs o E per la base eco / la base in vetro.

ihre freie auswahl

mehr als ungläubliche 4.500 möglichkeiten für ihr ganz persönliches stoppersystem! kombinieren sie: A gurtmechanismus + B pfosten und für die master basis C dekorscheibe + D trittschutzring oder E für die eco basis bzw. die glasbasis.

your free choice

more than 4.500 incredible ways to create your favoured stopper guideline system! just choose your combination: A housing + B post and for the master base C insert + D abs protection or E for eco base resp. the glass base.

master base

MADE IN EU design by KD



IT molteplicità d'uso, flessibilità e sicurezza: tutto questo è il sistema modulare e componibile stopper. la base è composta da un rivestimento esterno e di protezione in abs, da piastre in acciaio per dare stabilità al sistema e da inserti centrali decorativi in diverse finiture. il punto forte e la novità assoluta sono gli inserti centrali in vetro: facili e veloci da personalizzare grazie alla stampa digitale!

DE vielfalt, flexibilität, sicherheit: das modulare stopper-system. die basis besteht aus einem abs-trittschutz-ring, stahlplatten für sicheren stand und dekorscheiben in diversen ausführungen. der besondere clou sind die dekorscheiben aus sicherheitsglas: mit digitaldruck schnell personalisiert!

EN variety, flexibility, security: the modular stopper-system. the base is composed by a step-on protection ring made of abs plastics, steel-plates for firm standing and decorative plates in different versions. exceptional are the decorative plates made of tempered glass: with digital printing easily customised!



stopper wall

MADE IN EU design by KD

eco base

MADE IN EU design by KD



IT più leggera ed anche più economica è la variante minimalista della base stopper: disco in acciaio e copertura abs in diversi colori, combinabili con tutti i tubi e i nastri stopper. a causa della diminuzione del peso, la lunghezza del nastro è di massimo 2,5m.

DE leichter und günstiger präsentiert sich die ökonomische und schlanke variante der stopperbasis: stahlplatte und abs-abdeckung in diversen farben kombinierbar mit allen stopper pfosten und gurten. aufgrund des verringerten gewichts ist der gurtauszug auf 2,5m limitiert.

EN lighter and more economic is the leaner version of the stopper base: steel weight plate with abs cover in different colours combinable with all stopper posts and webbings. due to the reduced weight the webbing pull out is limited to 2,5m.

IT attacco a parete stopper: con l'attacco a parete avete a disposizione lo stesso raccordo a 4 direzioni delle colonnine a terra, ma non solo: il nastro infatti potrà fuoriuscire dall'attacco a parete sia sul fronte che di lato, ma anche dalla quarta via d'uscita, posteriore, nel caso in cui l'attacco a parete venisse montato in un luogo nascosto dietro ad un muro o ad un mobile, per esempio. l'attacco a parete insomma si fa notare solo se serve e nel caso in cui debba essere utilizzato, altrimenti rimarrà nascosto. completate il fissaggio del nastro montando alla parete l' attacco "stopper clip " oppure agganciatelo al meccanismo di un' altra colonnina stopper.

DE ohne pfosten und basis: mit der wandhalterung steht ihnen auch das komplette 4-wege system von stopper zur verfügung. nicht nur die auszüge parallel und rechtwinklig zur montagefläche, sondern auch der 4. auszug rückseitig. den 4. auszug setzen sie dann ein, wenn sie die wandhalterung verdeckt montieren. hinter trockenbauwänden oder in möbeln installiert, macht sich ihr stopper dann nur im bedarfsfall bemerkbar. alle stopper-gurtkassetten passen in den wandhalter. als gegenstück zum einhängen des gurt, wandmontieren sie einfach den stopper clip. je nach räumlicher gegebenheit können sie natürlich auch an ein stopper pfosten-element anschliessen.

EN no post, no base: use the 4-way system of stopper also with wall mount. you can use the pullouts forward or parallel to the wall and the 4th direction backwards as well. this direction is used when you mount the supports hidden behind walls or integrated in furniture. as counterpart just wallmount the stopper clip. depending on the location you can, of course, also connect the webbing to another stopper post.

stopper wall

n° articolo artikelnr. product nr.			
1	STWH130CM	stopper wall mount chrome-plated, 1pc	40,00€
2	STWH130AR	stopper wall mount silver coated, 1pc	40,00€
3	STWC90	stopper wallclip, 1pc	14,00€

STWH130CM

cromo/chrom/chrome

STWH130AR

argento/silber/silver

attacco a parete in cromo lucido STWH130CM oppure in argento satinato STWH130AR, comprensivo di viti e tasselli per il montaggio stopper wandhalterung hochglanz verchromt STWH130CM oder silbermatt veredelt STWH130AR, inkl. schrauben und dübel für die wandmontage

stopper wall support high-gloss chrome-plated STWH130CM or silver satined STWH130AR, incl. screws and dowels for mounting

STWC90

stopper clip a muro in ottone nichelato, comprensivo di viti e tasselli per il montaggio

stopper wandclip messing vernickelt inkl. schraube und dübel für die wandmontage

stopper wallclip, nickel-plated brass, incl. screws and dowels for mounting



stopper

Stopper®
transporter



my stopper >>>



IT dirigete con stopper e approfittate di un nuovo spazio pubblicitario: il nastro è personalizzabile con serigrafia o stampa digitale. raccomandiamo la serigrafia per loghi aziendali o scritte semplici; con la stampa digitale invece potremo realizzare per voi immagini in policromia e di maggiore impatto grafico. la stampa digitale, inoltre, permetterà di stampare a tutta superficie il colore della vostra azienda. per ulteriori dettagli non esitate a contattarci, saremo sempre a vostra completa disposizione.

DE zeigen sie mit stopper wo's langgeht und nutzen sie die möglichen zusätzlichen werbeflächen. der gurt kann mit siebdruck oder digital personalisiert werden. für einfache logos und schriftzüge empfehlen wir den siebdruck, während mit digitaldruck vielfarbigkeit und tolle effekte realisiert werden. sie können den gurt z.b. auch in der farbe ihres firmen corporates bedrucken lassen. dies empfiehlt sich auch bei geringen stückzahlen. fragen sie uns, wir beraten sie gerne.

EN show the way with stopper and use additional advertising space. the webbing can be customized with serigraphy or digital printing. for simple logos and words we recommend screen printing, while digital printing can make polychrome and sophisticated designs. you can also print the webbing to match your company's corporate colours. even small quantities are not a problem. ask us for more detailed information.



IT utilizzate il vostro stopper per attirare l'attenzione: il tubo in policarbonato trasparente e antiurto diventa una superficie pubblicitaria aggiuntiva oppure un decorativo espositore per oggetti. togliete il meccanismo avvolginastrò ed inserite nel tubo una stampa digitale o dei piccoli oggetti. grazie alla speciale struttura il contenuto del tubo si può cambiare a piacere ed in ogni momento. inoltre, l'effetto pubblicitario è ulteriormente accentuato grazie alla speciale base stopper, anch'essa personalizzabile a piacere e velocemente.

DE nutzen sie ihr stoppersystem als hingucker: der pfosten aus transparentem, schlagfestem polycarbonat wird zur zusätzlichen werbefläche oder einem dekorativem objektpräsentier. sie nehmen den gurtmechanismus ab und bestücken den pfosten mit einem druck oder kleinen objekten. durch die spezielle konstruktion lässt sich der inhalt schnell und einfach jederzeit austauschen. mit dem glaseinsatz der basis steigern sie diesen marketing effekt noch: auch sie lässt sich jederzeit schnell und einfach mit print personalisieren.

EN make your stopper an eye catcher: the post made of transparent, shock-resistant polycarbonate becomes an additional advertising space or a stylish item display. just unscrew the webbing mechanism and fill the post with a print or small items. thanks to the particular design the content can be exchanged easily anytime. and with the special stopper base glass inset you can boost your marketing effect even more: customize the base with a print in no time at all.



stopper



5
stopquick
32,-



2
stopbag
49,-



1
stophold
33,-

stopper accessories

MADE IN EU design by KD



1
STH250230CM
stophold sostegno cromo lucido, 230mmx250mm (hxb)
stophold haltebügel, hochglanzverchromt, 230mmx250mm (hxb)
stophold display holder, high-gloss chrome-plated, 230mmx250mm (hxb)



2
STB305240GL
stopbag tasca portadepliant in acrilico color vetro, spessore 3mm, per formato DIN A4, inclinata di circa 30°, adatta per circa 200 fogli singoli
stopbag acrylglas prospekttasche, 3mm, DIN A4 format, 30° neigung für ca. 200 einzelblattprospekte
stopbag glassgreen acrylic brochure pocket, thickness 3mm for DIN A4 format, inclination 30° for approx. 200 single sheet brochures

IT moltiplicate le funzioni del vostro sistema stopper, attacco a parete o tex. avvitare il sostegno universale ad U alla colonnina, scegliere ed inserire i supporti in acrilico nel sostegno ad U. tutti i supporti sono intercambiabili. il nostro consiglio: tali supporti in acrilico sono compatibili anche con flip e flippy, della linea zip.

DE erweitern sie mit den stopper accessoiress stopper, stopper wandhalter oder tex. universal haltebügel stophold einfach aufgeschraubten, das passende acrylglas-display auswählen und einschieben. displays können jederzeit gewechselt werden. unser tip: alle displays passen auch zu flip und flippy der zip serie.

EN upgrade your stopper, stopper wall or tex system with the accessories. stophold support is simply screwed on all stopper versions. then choose the needed acrylic glass display and insert it into stophold. you can replace the displays anytime. our tip: all displays match also with the zip items flip and flippy.

stopper accessories

n° articolo artikelnr. product nr.			
1	STH250230CM	stophold, 1pc	33,00€
2	STB305240GL	stopbag, 1pc	49,00€
3	STU305240GL	stopup, 1pc	39,00€
4	STS303240GL	stopshelf, 1pc	48,00€
5	STQ302240GL	stopquick, 1pc	32,00€
6	STPQ1A4	stoppix one side, 1pc	24,00€
7	STF302240GL	stopfix, 1pc	24,00€
8	STT400400B SALE	stoptable, 1pc	119,00€

* fino ad esaurimento scorte | solange vorrat reicht | while stock last



3



4



5



6



7

STU305240GL
stopup portaposter a tasca in acrilico color vetro, spessore 3mm, per formato DIN A4, inclinato di 45°, inserimento del foglio laterale
stopup acrylglas-posterhalter 3mm stark für ein einzelblatt im DIN A4 format, 45° neigung, seitlicher ein Schub
stopup glassgreen acrylic poster holder, thickness 3mm, for one single sheet in DIN A4 format, inclination 45°, insertion sideways

STS303240GL
ripiano stopshelf in acrilico color vetro, spessore 3mm, per formato DIN A4, inclinato di 45°, profondità del ripiano 40mm
acrylglas-ablage stopshelf 3mm stark für DIN A4 format, 45° neigung, ablagertiefe 40mm
stopshelf glass-green acrylic shelf, thickness 3mm for DIN A4 format, inclination 45°, shelf depth 40mm

STQ302240GL
stopquick portaposter a tasca in acrilico color vetro, spessore 3mm, per formato DIN A4, con calamita per la chiusura, verticale, mono e bifacciale
stopquick acrylglas-posterhalter 3mm, für ein einzelblatt DIN A4 format, ein- und beidseitige ansicht, öffnung mit magnetverschluss
stopquick glassgreen acrylic poster holder, thickness 3mm, for one single sheet in DIN A4 format, vertical, front and rear view, magnetic lock

STPQ1A4
stoppix A4 monofacciale e bifacciale: poster display privo di cornici, policarbonato trasparente
stoppix A4 ein- und doppelseitig: rahmenloses posterdisplay, transparentes polycarbonat
stoppix A4 single-sided: frameless poster display, transparent polycarbonate

STF302240GL
stopfix pannello singolo per informazioni in acrilico color vetro, spessore 3mm, per formato DIN A4, mono e bifacciale, per cartelli di direzione e di indicazione
acrylglas-infoschild stopfix im DIN A4 format, stehend, ein- und beidseitige ansicht, für individuelle gestaltung und beschriftung
glass-green acrylic information sign stopfix in DIN A4 format, vertical, front and rear view, for individual design and print



STT400400B
stoptable: tavolino in faggio massiccio, 400x400x20mm. materiale per il montaggio incluso
stoptable: tischplatte, buche massiv, 400x400x20mm inkl. montagmaterial
stoptable: desk top, solid beech wood, 400x400x20mm incl. mounting material



8

stopper



1 2 3 4
price for this combination
164,-

wave

MADE IN EU design by KD

1 **STTATUAL**
tubo per tavolo: tubo in alluminio anodizzato color argento
pfosten für tische: silber eloxiertes aluminium
post for table: silver anodized aluminium

2 **STTWAR**
wave: tavolino in mdf verniciato in color argento, 689x417x19mm, con viti e connettori
wave: tischplatte, mdf silber lackiert, 689x417x19mm, schrauben, platten-verbinder
wave: table top, mdf silver coated, 689x417x19mm, with screws and connectors

3 **STKABSAR**
base protezione: abs stampato ad iniezione color argento con piastra
basis trittschuttring: abs-spritzguss versilbert mit bodenplatte
base step on protection: abs mold injection, silver plated with weight plate

4 **STKINSAL**
inserto decorativo: alluminio anodizzato color argento
dekor inlay: silber eloxiertes aluminium
decorative inlay: silver anodized aluminium



IT create dei ripiani modulari con i tavolini wave: ondulari, a cerchio o semicerchio, oppure in segmenti, a seconda delle proprie esigenze. per la base potete scegliere tra tutti gli elementi della linea stopper master. tramite un inlay su vetro si può per esempio personalizzare facilmente la base con delle stampe. ogni tavolino viene fornito con i connettori appositi. collegate wave in sale di attesa, decorate stand fieristici oppure create delle barriere per eventi particolari.

DE mit wave tischen können sie modular theken zaubern: wellenförmig, als kreise, halbkreise oder segmente ganz nach bedarf. als basis können sie alle elemente der stopper master basis verwenden. mit glasinlay lässt sich die basis zum beispiel mit druck personalisieren. jede tischplatte hat die passenden verbinder schon dabei. binden sie wave in wartebereiche ein, gestalten sie messstände oder absperungen bei events.

EN create modular counters with the wave tables: s-shaped, in circles, semi-circles or segments always according to your needs. for the base all elements of the stopper master base can be chosen. with glass inlay the base can be customized easily with prints. every table top comes already with the matching connectors. integrate wave in waiting areas, design fair stands or create barriers for events.

wave

n° articolo artikelnr. product nr.			
1	STTATUAL	table post silver anodized aluminium, 1pc	30,00€
2	STTWAR	table top wave silver, 1pc	70,00€
3	STKABSAR	base abs ring silver, 1pc	45,00€
4	STKINSAL	base inlay aluminum silver, 1pc	19,00€

combinations

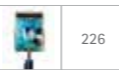

226



1 3 4 5
price for this combination
133,-

rondo

MADE IN EU design by KD

IT assicurarsi superfici polyvalenti con il tavolino rondo della linea stopper: per la base si può scegliere tra tutti gli elementi della linea stopper master. i tavolini sono disponibili sia in vetro che in legno color argento. si possono combinare anche entrambi i tipi, ottenendo così una superficie personalizzabile. inoltre si può aggiungere la base in vetro, da personalizzare tramite un print inlay. anche gli accessori stopper sono combinabili con queste varianti, tramite un facile avvittamento. rondo si monta facilmente, e grazie alle molteplici superfici pubblicitarie, è consigliato specialmente per fiere, eventi, negozi, showroom ed uffici.

DE mit den rondo tischen aus dem stopper programm mehrwert sichern: für die basis stehen ihnen alle elemente der stopper master basis zur auswahl. tischplatten sind in glas oder silber erhältlich. oder sie kombinieren beide platten miteinander und erhalten eine schnell personalisierbare werbefläche. dazu passt die ebenfalls schnell mit printinlay gestaltete basis mit glaseinsatz. selbst stopper accessoires passen dazu: einfach zum aufschrauben. rondo ist schnell aufgestellt und empfiehlt sich v.a. durch seine zusätzlichen marketing flächen für messen, events, shop, showroom und office.

EN gain publicity space with the rondo tables: for the base you can choose out of all elements of the master base. the table tops are available in glass or silver. you can also combine both tops with each other and get a quick customizable new marketing area. matching with this is the base with glass inset, customized with a print inlay in no time at all. even the stopper accessories match with this: just screw them on top. rondo is set up in no time and thanks to its additional ad spaces it is especially recommended for exhibitions, events, shops, showrooms and offices.

rondo

n° articolo artikelnr. product nr.			
1	STTATUAL	table post silver anodized aluminium, 1pc	30,00€
2	STROVE	rondo table top glass, 1pc	35,00€
3	STROAR	rondo table top silver, 1pc	39,00€
4	STKABSAR	base abs ring silver, 1pc	45,00€
5	STKINSAL	base inlay aluminum silver, 1pc	19,00€

* fino ad esaurimento scorte | solange vorrat reicht | while stock last

combinations

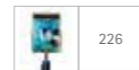

226



1 **STTATUAL**
tubo per tavolo: tubo in alluminio anodizzato color argento
pfosten für tische: silber eloxiertes aluminium
post for table: silver anodized aluminium

2 **STROVE**
STROAR
rondo: tavolino in vetro temperato o in mdf color argento, 480x480x8mm
rondo: tischplatte temperiertes glas oder mdf silber lackiert, 480x480x8mm
rondo: table top, tempered glass or mdf silver coated 480x480x8mm

3 **STKABSAR**
base protezione: abs stampato ad iniezione color argento con piastra
basis trittschuttring: abs-spritzguss versilbert mit bodenplatte
base step on protection: abs mold injection, silver plated with weight plate

4 **STKINSAL**
inserto decorativo: alluminio anodizzato color argento
dekor inlay: silber eloxiertes aluminium
decorative inlay: silver anodized aluminium

stopper



tex

MADE IN EU design by KD

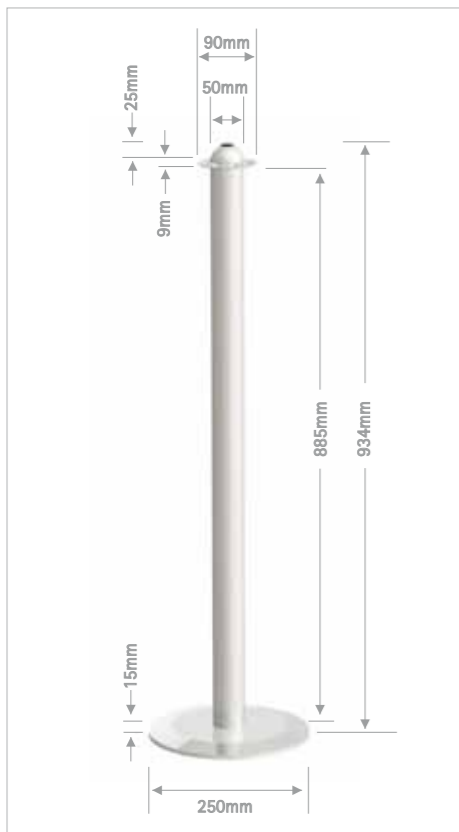

IT stopper tex è la variante classica del sistema guidalinee eliminacode. grazie all'utilizzo di materiali nobili e ad una lavorazione di qualità, lo stopper tex è particolarmente indicato per gli ambienti eleganti di ricevimento, come le hall di un albergo, per le mostre e le rappresentazioni in musei o teatri o anche per dare un tocco di raffinata eleganza allo showroom. stopper tex mette a vostra disposizione la possibilità di agganciare fino a 8 corde ad una sola colonnina. i morsetti, eleganti e funzionali, rendono l'aggancio facile e sicuro. grazie al meccanismo di sicurezza dei morsetti non è possibile che si sgancino inavvertitamente. ogni stopper tex è dotato, nella parte superiore, di un foro filettato M8 per l'utilizzo degli accessori in programma

DE stopper tex ist die klassische variante des personenleitsystems. mit den edlen materialien in hochqualitativer verarbeitung empfiehlt sich stopper tex vor allem für das elegante ambiente im empfangsbereich, in hotelfoyers, für besondere ausstellungsstücke in museen oder im showroom. der pfosten bietet acht möglichkeiten die seile einzuhängen. formschöne clips rasten einfach und sicher ein. durch den karabiner-effekt wird unbeabsichtigtes lösen verhindert. alle stopper tex haben ein M8 gewinde passend für alle elemente des stopper zubehörprogramms.

EN stopper tex is the classic way of crowd control. high class material with high quality finish characterises stopper tex. especially for the elegant ambience in reception areas or hotel foyers as well as for exceptional exhibits in museums or showrooms stopper tex is recommended. the post has eight openings to hang in the rope. shapely clips make the attaching easy and safe. the karabiner-like closing prevents from unintended opening or sliding out. all stopper tex have a M8 thread suitable for all elements of the stopper accessories assortment.



IT elegante, raffinato e di qualità: ecco come si presenta stopper tex. la base e il tubo sono realizzati in acciaio polito. la testina superiore è invece realizzata in ottone. tutte le parti che compongono stopper tex sono rifinite con una cromatura lucida di protezione. potete scegliere tra la versione in cromo lucido e la versione in color ottone lucido. stopper tex è alto 940mm e poggia in modo sicuro su una base del diametro di 250mm.

DE formschön und hochwertig präsentiert sich stopper tex. basis und pfosten sind aus poliertem stahl. das kopfteil aus messing-drehteilen. alle teile sind hochglanz veredelt. wählen sie zwischen der farbausführung in messing oder chrom. stopper tex ist 940mm hoch und steht sicher auf der basis mit 250mm durchmesser.

EN stopper tex introduces itself with elegancy and high-grade materials. base and post are made of polished steel. the sphere is composed of turned brass pieces. all parts are high-gloss finished. choose between brass- or chrome-plated. stopper tex is 940mm high and stands firmly on the base with 250mm diameter.

tex

n° articolo artikelnr. product nr.		chrome	
1	TXBASECM	base chrome-plated, 1pc	92,40€
2	XTUBOCM	post chrome-plated, 1pc	69,00€
brass-plated			
3	TXBASEOT	base brass-plated, 1pc	109,00€
4	XTUBOOT	post brass-plated, 1pc	99,00€

XTUBOCM
tubo tex: cromo lucido
pfosten tex: verchromt
tex post: chrome-plated

TXBASECM
base tex: cromo lucido ø250mm
basis tex: verchromt ø250mm
tex base: chrome-plated ø250mm

1 + 2
price for this combination

161,40



XTUBOOT
tubo tex: ottonato lucido
pfosten tex: vermessingt
tex post: brass-plated

TXBASEOT
base tex: ottonato ø250mm
basis tex: vermessingt ø250mm
tex base: brass-plated ø250mm

3 + 4
price for this combination

208,-



stopper



tex double

MADE IN EU design by KD



IT grazie al doppio sistema di aggancio per le corde non raddoppiate solo la sicurezza ma anche l'effetto di stopper tex. il secondo aggancio è mobile e si può posizionare a piacere sulla colonnina, all'altezza desiderata. i due agganci sono compatibili con tutte le corde della nostra gamma. che sia con la classica corda in polipropilene o con il robusto cavo di acciaio, il nostro assortimento tex offre la soluzione giusta per ogni ambiente.

DE verdoppeln sie nicht nur die sicherheit, sondern auch die wirkung mit dem zweifachen seilhalter-system. der zweite halter ist verschiebbar und wird einfach auf die gewünschte höhe eingestellt. beide halter sind kompatibel mit allen seilen aus unserem programm. ob seile aus edelstahl oder farbigem polypropylen, unser tex sortiment bietet das richtige für jedes ambiente.

EN duplicate not only the security but also the look with the double rope support. the second support can move along the post and is simply adjusted to the desired height. both supports match with all our ropes. the tex assortment offers you ropes made of stainless steel and coloured polypropylen going with every ambiente.

tex double

n° articolo | artikelnr. | product nr.

1	TXBASECM	base chrome, 1pc	92,40€
2	TXTUBO2CM	post chrome 2 support, 1pc	104,60€
3	TXBASEOT	base brass, 1pc	109,00€
4	TXTUBO2OT	post brass 2 support, 1pc	99,00€

combinations

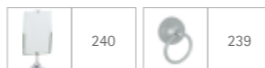

TXTUBO2CM

tubo tex: cromo lucido con doppio aggancio per corde

pfosten tex: verchromt mit doppel-seilhalter

tex post: chrome-plated with double cord support

TXBASECM

base tex: cromo lucido ø250mm

basis tex: verchromt ø250mm

tex base: chrome-plated ø250mm

1 + 2
price for this combination

197,-



TXTUBO2OT

tubo tex: ottonato con doppio aggancio per corde

pfosten tex: vermessingt mit doppelseilhalter

tex post: brass-plated with double cord support

TXBASEOT

base tex: ottonato ø250mm

basis tex: vermessingt ø250mm

tex base: brass-plated ø250mm

3 + 4
price for this combination

208,-



stopper



tex alu

MADE IN EU design by KD



tex mini

MADE IN EU design by KD



TXTUBOAL

tubo tex alu: alluminio anodizzato, attacco corda ottone cromo lucido e argento satinato

pfosten tex alu: eloxiertes aluminium, seilhalter messing verchromt und versilbert

post tex alu: anodized aluminium, cord support brass silver- and chrome-plated

TXBASEAL

base tex alu: sistema modulare con piastra ferro, copertura in abs grigio chiaro, inserto alluminio anodizzato color argento, ø240mm

basis tex alu: modulare basis ø240mm mit grundplatte in eisen, abs-abdeckung lichtgrau, dekoreinsatz silber eloxiertes aluminium

base tex alu: modular base ø240mm with iron plate, abs cover light grey, silver anodized aluminium inset

1 + 2

price for this combination

79,-



IT tex alu rappresenta una versione economica e semplice, mantenendo tutti i vantaggi del sistema tex. l'alluminio di alta qualità del tubo non solo lo rende elegante ma anche resistente nel tempo. grazie allo speciale design la base del vostro tex alu è stabile e allo stesso tempo robusta. il supporto, comprensivo di 8 buchi per il cordone, e la semisfera sono rispettivamente in ottone color cromo lucido ed argento satinato. nelle pagine successive potrete trovare tutte le corde combinabili. anche stopper tex è comprensivo del filetto che permette di avvitare tutti gli accessori stopper.

DE tex alu bietet als ökonomische, schlanke version alle vorteile des tex-systems. das hochwertige silber eloxierte aluminium des pfostens sieht gut aus und ist dabei langlebig. durch das spezielle design der basis ist ihr tex alu stabil und widerstandsfähig zugleich. 8-loch seilhalter und halbkugel sind aus verchromtem bzw. versilbertem messing. die passenden seile finden sie auf den folgenden seiten. auch der tex alu ist mit einem passenden gewinde versehen, in das die stopper accessoires einfach eingeschraubt werden.

EN tex alu is a leaner and more economic version with all the advantages of the tex-system. the high-grade silver anodized aluminium makes the post not only look good but also durable. the special design of the base makes your tex alu stable and sturdy at the same time. the 8-hole cord support and the semisfere are made of chrome- resp. silver-plated brass. appropriate cords you'll find on the following pages. tex alu also comes with a thread matching for all stopper accessories.

tex alu

n° articolo | artikelnr. | product nr.

1	TXBASEAL	tex base aluminium, 1pc	30,00€
2	TXTUBOAL	tex post aluminium, 1pc	49,00€

combinations

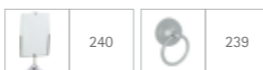

IT tex mini è sempre utile quando si deve "bloccare" senza limitare il campo visivo: per presentazioni di veicoli, sculture e opere d'arte in genere, oggetti a terra come mosaici o rilievi. tex mini è in prima linea per garantirvi un sistema di sbarramento efficace ed al contempo un ottimo sistema guidalinee. gli oggetti presentati verranno protetti ma non nascosti rimanendo così al centro dell'attenzione. utilizzate indifferentemente tutte le corde del sistema tex anche per tex mini.

DE tex mini kommt immer dann zum einsatz, wenn sie absperren aber nicht den blick verstellen möchten: fahrzeugpräsentation, kunst wie skulpturen oder besondere bodenobjekte wie mosaik oder reliefs. tex mini ist daher weniger leit- als absperresystem. präsentierte objekte werden geschützt, aber nicht verstellt, und bleiben im mittelpunkt. alle seile der tex serie passen auch zum tex mini.

EN tex mini is your right choice when you want to close off objects without putting them out of sight: presentation of vehicles, art objects like sculptures or floor reliefs and mosaics. tex mini is thus less a guideline but more of a close-off-system. presented items are protected, while remaining visible. all ropes of the tex series also match the tex mini.

tex mini

n° articolo | artikelnr. | product nr.

1	TXBASEAL	tex base aluminium, 1pc	30,00€
2	TXMITUBOAL	tex post mini aluminium, 1pc	43,00€

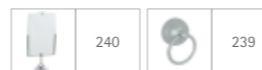

combinations

TXMITUBOAL

tubo tex alu: alluminio anodizzato, attacco corda ottone cromo lucido e argento satinato

pfosten tex alu: eloxiertes aluminium, seilhalter messing verchromt und versilbert

post tex alu: anodized aluminium, cord support brass silver- and chrome-plated

TXBASEAL

base tex alu: sistema modulare con piastra ferro, copertura in abs grigio chiaro, inserto alluminio anodizzato color argento, ø240mm

basis tex alu: modulare basis ø240mm mit grundplatte in eisen, abs-abdeckung lichtgrau, dekoreinsatz silber eloxiertes aluminium

base tex alu: modular base ø240mm with iron plate, abs cover light grey, silver anodized aluminium inset

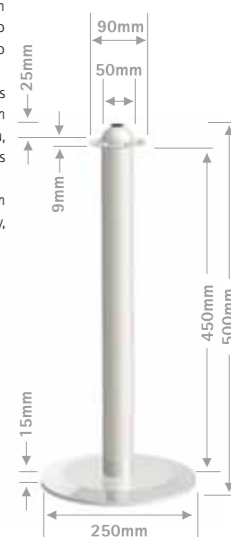

stopper



agganciare bannerblock alla ghiera, tendere teso il banner e fissare la ghiera sul tubo
 bannerblock im ring einhängen, spannen und fixieren
 attach the bannerblock to the ring, then tighten the banner and fix the ring

tex wall

MADE IN EU design by KD

struttura modulare: combina il set base con il modulo di aggiuntivo modulare bauweise - basis set mit erweiterungsmodul kombinieren
 modular set up: combine the base set with the extension module

tex wall: banner 850x900 (hwx).

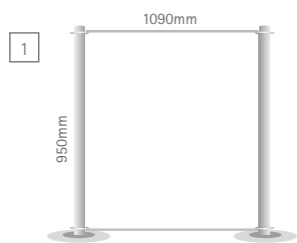

IT tex wall abbina il sistema tex alu con i profili ad incastro bannerblock. il set di base è composto da due colonnine con base e da un set bannerblock. inserire i banner nei profili ed agganciarli semplicemente agli appositi supporti tex wall. può essere ampliato secondo le esigenze del momento. il set modulare per l'ampliamento è composto da una colonnina e da due profili ad incastro. grazie ai supporti anulari, ogni modulo texwall può essere sistemato anche in maniera non lineare per creare pareti angolari o a „zigzag“. vi consigliamo gli accessori della serie tex anche per tex wall.

DE tex wall verbindet das tex system mit dem aluminiumklemmprofil bannerblock. das grundset enthält je 2 stabile pfosten mit basis sowie je ein set bannerblock. banner in die profile einklemmen und einfach an den entsprechenden haltern einhängen. tex wall kann je bedarf modular erweitert werden. das erweiterungsset enthält einen pfosten mit basis und zwei bannerblock. durch die ringförmigen halter, können sie jedes texwall modul auch gewinkelt anfügen und einfach über eck oder im zickzack fortlaufende wände bauen. alle aufschraubbaren accessoires der tex serie passen auch zu tex wall

EN texwall blends the stopper tex alu with bannerblock, the aluminium snap profile. the set is composed of two posts with base and a set of bannerblock. insert the banner into the profiles and easily hook them into the appropriate supports. tex wall can be extended with the modular set, to create structures of various dimensions. this modular set is made up from one post and two bannerblock. thanks to the circular supports, each tex wall can be either angled to create walls or zig zag or even create angular shapes. all the tex accessories that can be screwed onto the post, match also with tex wall.

tex wall

n° articolo artikelnr. product nr.			
1	TXW950	tex wall 950x1090mm, 1pc	199,00€
2	TXW950M	tex wall module 950mm h, 1pc	129,00€
3	STH250230CM	stophold, 1pc	33,00€
4	STB305240GL	stopbag, 1pc	49,00€
5	STU305240GL	stopup, 1pc	39,00€



STH250230CM
 stophold sostegno cromo lucido, 230mmx250mm (hxb)
 stophold haltebügel, hochglanzverchromt, 230mmx250mm (hxb)
 stophold display holder, high-gloss chrome-plated, 230mmx250mm (hxx)



STB305240GL
 stopbag tasca portadepiant in acrilico color vetro, spessore 3mm, per formato DIN A4, inclinata di circa 30°, adatta per circa 200 fogli singoli
 stopbag acrylglas prospekttasche, 3mm, DIN A4 format, 30° neigung für ca. 200 einzelblattprospekte
 stopbag glassgreen acrylic brochure pocket, thickness 3mm for DIN A4 format, inclination 30° for approx. 200 single sheet brochures



STU305240GL
 stopup portaposter a tasca in acrilico color vetro, spessore 3mm, per formato DIN A4, inclinato di 45°, inserimento del foglio laterale
 stopup acrylglas-posterhalter 3mm stark für ein einzelblatt im DIN A4 format, 45° neigung, seitlicher ein Schub
 stopup glassgreen acrylic poster holder, thickness 3mm, for one single sheet in DIN A4 format, inclination 45°, insertion sideways



combinations

240



tex cord

MADE IN EU design by KD



IT materiali di prima qualità e ampia scelta caratterizzano anche le corde a disposizione per lo stopper tex. le corde in polipropilene vengono intrecciate appositamente per il nostro stopper tex. il materiale di cui sono composte non scolorisce ed è inoltre resistente a polvere e sporcizia. dalla nostra gamma potete scegliere 4 colori e 3 lunghezze standard. il morsetto è cromato lucido nelle finiture cromo e ottone. di particolare effetto è la nostra quinta variante, il cavo in acciaio inox. la clip vera e propria, nichelata, garantisce un sistema di chiusura che non può essere sganciato inavvertitamente.

DE hochwertige Materialien und vielfältige Auswahl auch bei den Seilen. speziell für stopper tex werden die Seile aus Polypropylen geflochten. das Material ist farbecht sowie staub- und schmutzabweisend. sie können aus vier Farben in jeweils drei Standardlängen wählen. die Seilkappe ist hochglanz vermessingt oder verchromt. der Verschlusskarabiner in lackierter Nickelausführung sorgt für einfache und sichere Befestigung des Seils.

EN stopper tex offers high-quality materials and manifold choice also for the ropes. exclusively for stopper tex the ropes are plaited in polypropylene. the material is colour fast as well as dust- and soil-resisting. the ropes come in four colours with three standard lengths. the rope connector is high-gloss chrome- or brass-plated. the rope is clipped safely and easily with the locking carabiner.



morsetto in cromo lucido con clip nichelata
seilkappe hochglanz verchromt mit karabiner-clip, vermessingt
rope connector chrome-plated with nickel-plated carabiner



morsetto in ottone lucido con clip nichelata
seilkappe hochglanz vermessingt mit karabiner-clip, vermessingt
rope connector brass-plated with nickel-plated carabiner



1 **TEXWHCM**
gancio stopper tex per parete in cromo lucido conf. a 1pz incl. viti e tasselli
stopper tex wandhalter verchromt packg. 1st inkl. schrauben und dübel
stopper tex wallclip chrome-plated; package 1pc incl. screws and dowels

lunghezza länge length	TEXSCMBL100	TEXSCMRS100	TEXSCMSW100	TEXSCMGR100
2 1000mm	25,00€	25,00€	25,00€	25,00€
3 1500mm	29,00€	29,00€	29,00€	29,00€
4 2000mm	35,00€	35,00€	35,00€	35,00€

lunghezza länge length	TEXSOTBL100	TEXSOTRS100	TEXSOTSW100	TEXSOTGR100
5 1000mm	34,00€	34,00€	34,00€	34,00€
6 1500mm	39,00€	39,00€	39,00€	39,00€
7 2000mm	45,00€	45,00€	45,00€	45,00€

lunghezza länge length	TEXSCMIX100	TEXSCMIX150	TEXSCMIX200
8 1000mm	28,00€		
9 1500mm	32,00€		
10 2000mm	36,00€		

altre lunghezze disponibili a richiesta | weitere längen auf anfrage | other sizes on demand

tex cord

n° articolo artikelnr. product nr.			
1	TEXWHCM	wallclip chrome, 1pc	10,00€
2	cord 1000mm (all colours), chrome-plated support	1pc	25,00€
3	cord 1500mm (all colours), chrome-plated support	1pc	29,00€
4	cord 2000mm (all colours), chrome-plated support	1pc	35,00€
5	cord 1000mm (all colours), brass-plated support	1pc	34,00€
6	cord 1500mm (all colours), brass-plated support	1pc	39,00€
7	cord 2000mm (all colours), brass-plated support	1pc	45,00€
8	cord 1000mm, stainless steel	1pc	28,00€
9	cord 1500mm, stainless steel	1pc	32,00€
10	cord 2000mm, stainless steel	1pc	36,00€

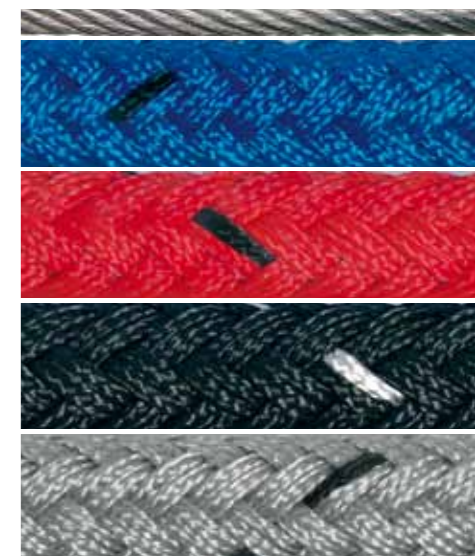



tex accessories

MADE IN EU design by KD

1 **STH250230CM**
 stophold sostegno cromo lucido, 230mmx250mm (hxb)
 stophold haltebügel, hochglanzverchromt, 230mmx250mm (hxb)
 stophold display holder, high-gloss chrome-plated, 230mmx250mm (hxb)

2 **STB305240GL**
 stopbag tasca portadepliant in acrilico color vetro, spessore 3mm, per formato DIN A4, inclinata di circa 20°, adatta per circa 200 fogli singoli
 stopbag acrylglas prospekttasche, 3mm, DIN A4 format, 20° neigung für ca. 200 einzelblattprospekte
 stopbag glassgreen acrylic brochure pocket, thickness 3mm for DIN A4 format, inclination 20° for approx. 200 single sheet brochures



IT con gli accessori della nostra gamma potete moltiplicare le funzioni del vostro sistema tex: informare, presentare o fare pubblicità non sono un problema. il sostegno universale ad U viene semplicemente avvitato sulla testina dello stopper tex, già dotate a foro filettato per questo utilizzo. i supporti in acrilico si inseriscono facilmente nel sostegno ad U e altrettanto facilmente possono essere cambiati in qualsiasi momento.

DE erweitern sie ihren tex: informieren, präsentieren oder bewerben ist mit den accessoires kein problem. der universal haltebügel stophold wird aufgeschraubt. stopper tex hat bereits das passende gewinde. das passende acrylglas-display auswählen und einschieben. die displays können sie jederzeit wechseln.

EN upgrade your tex: informing, presenting or advertising is no problem with the stopper elements. the holder stophold is screwed onto the post. choose the needed acrylic display and insert it into stophold. the displays are exchangeable anytime.

tex accessories

n° articolo artikelnr. product nr.			
1	STH250230CM	stophold, 1pc	33,00€
2	STB305240GL	stopbag, 1pc	49,00€
3	STU305240GL	stopup, 1pc	39,00€
4	STS303240GL	stopshelf, 1pc	48,00€
5	STQ302240GL	stopquick, 1pc	32,00€
6	STPQ1A4	stoppix 1 A4, 1pc	24,00€
7	STF302240GL	stopfix, 1pc	24,00€



3 **STU305240GL**
 stopup portaposter a tasca in acrilico color vetro, spessore 3mm, per formato DIN A4, inclinato di 45°, inserimento del foglio laterale
 stopup acrylglas-posterhalter 3mm stark für ein einzelblatt im DIN A4 format, 45° neigung, seitlicher ein Schub
 stopup glassgreen acrylic poster holder, thickness 3mm, for one single sheet in DIN A4 format, inclination 45°, insertion sideways

4 **STS303240GL**
 ripiano stopshelf in acrilico color vetro, spessore 3mm, per formato DIN A4, inclinato di 45°, profondità del ripiano 40mm
 acrylglas-ablage stopshelf 3mm stark für DIN A4 format, 45° neigung, ablagertiefe 40mm
 stopshelf glass-green acrylic shelf, thickness 3mm for DIN A4 format, inclination 45°, shelf depth 40mm

5 **STQ302240GL**
 stopquick portaposter a tasca in acrilico color vetro, spessore 3mm, per formato DIN A4, con calamita per la chiusura, verticale, mono e bifacciale
 stopquick acrylglas-posterhalter 3mm, für ein einzelblatt DIN A4 format, ein- und beidseitige ansicht, öffnung mit magnetverschluss
 stopquick glassgreen acrylic poster holder, thickness 3mm, for one single sheet in DIN A4 format, vertical, front and rear view, magnetic lock

6 **STPQ1A4**
 stoppix A4 monofacciale e bifacciale: poster display privo di cornici, policarbonato trasparente
 stoppix A4 ein- und doppelseitig: rahmenloses posterdisplay, transparentes polycarbonat
 stoppix A4 single-sided: frameless poster display, transparent polycarbonate

7 **STF302240GL**
 stopfix pannello singolo per informazioni in acrilico color vetro, spessore 3mm, per formato DIN A4, mono e bifacciale, per cartelli di direzione e di indicazione
 acrylglas-infoschild stopfix im DIN A4 format, stehend, ein- und beidseitige ansicht, für individuelle gestaltung und beschriftung
 glass-green acrylic information sign stopfix in DIN A4 format, vertical, front and rear view, for individual design and print